

P- Voorgevel
schaal: 1 : 75

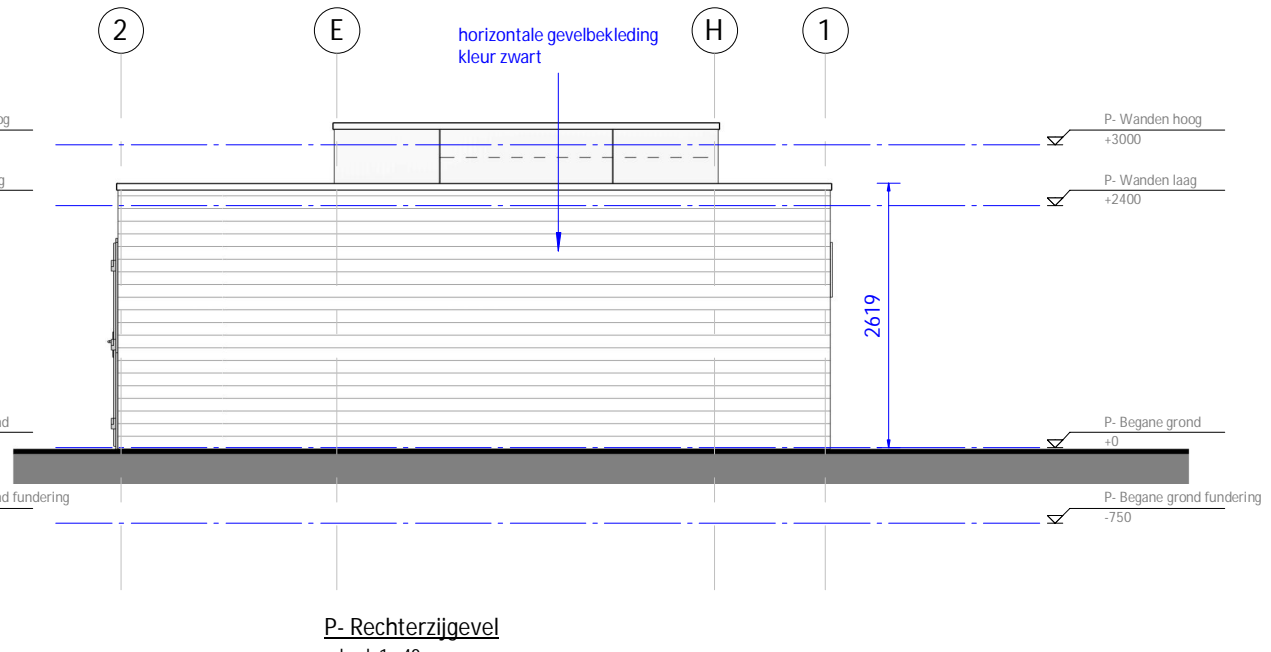

P- Rechterzijgevel
schaal: 1 : 40

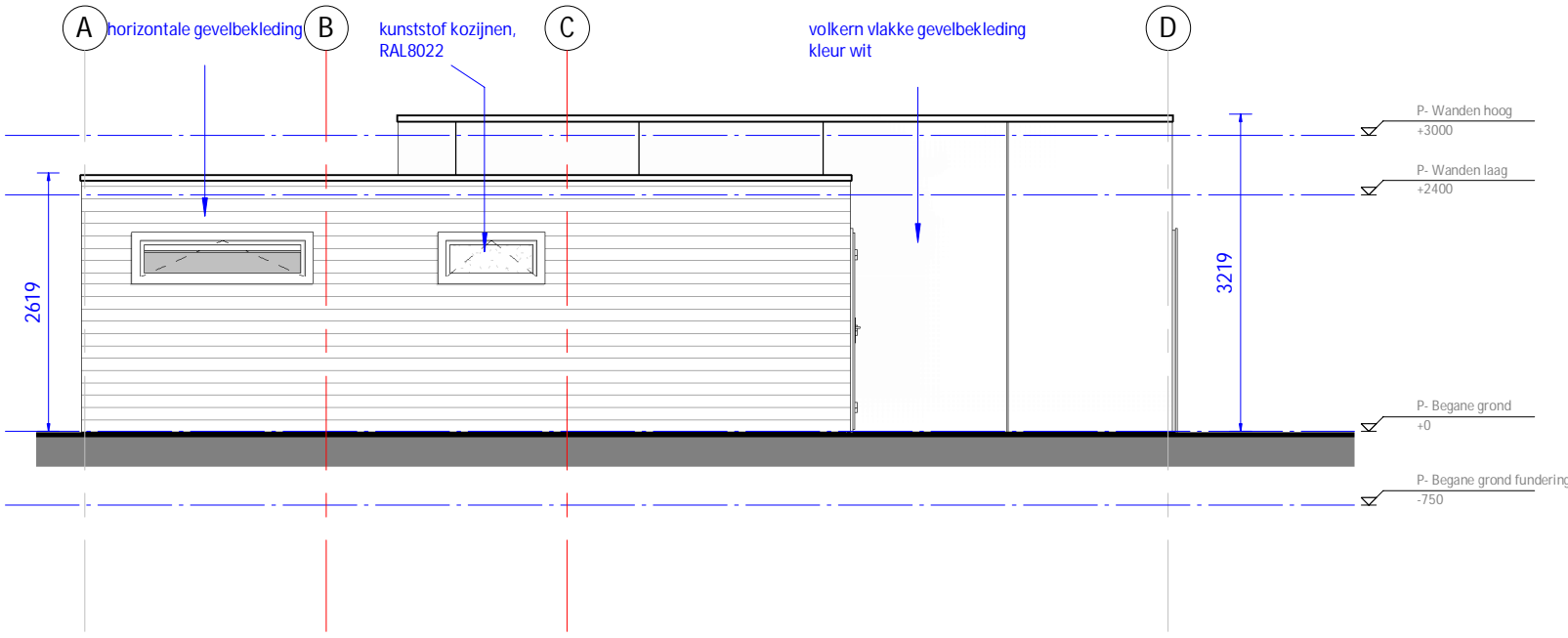

P- Achtergevel
schaal: 1 : 40

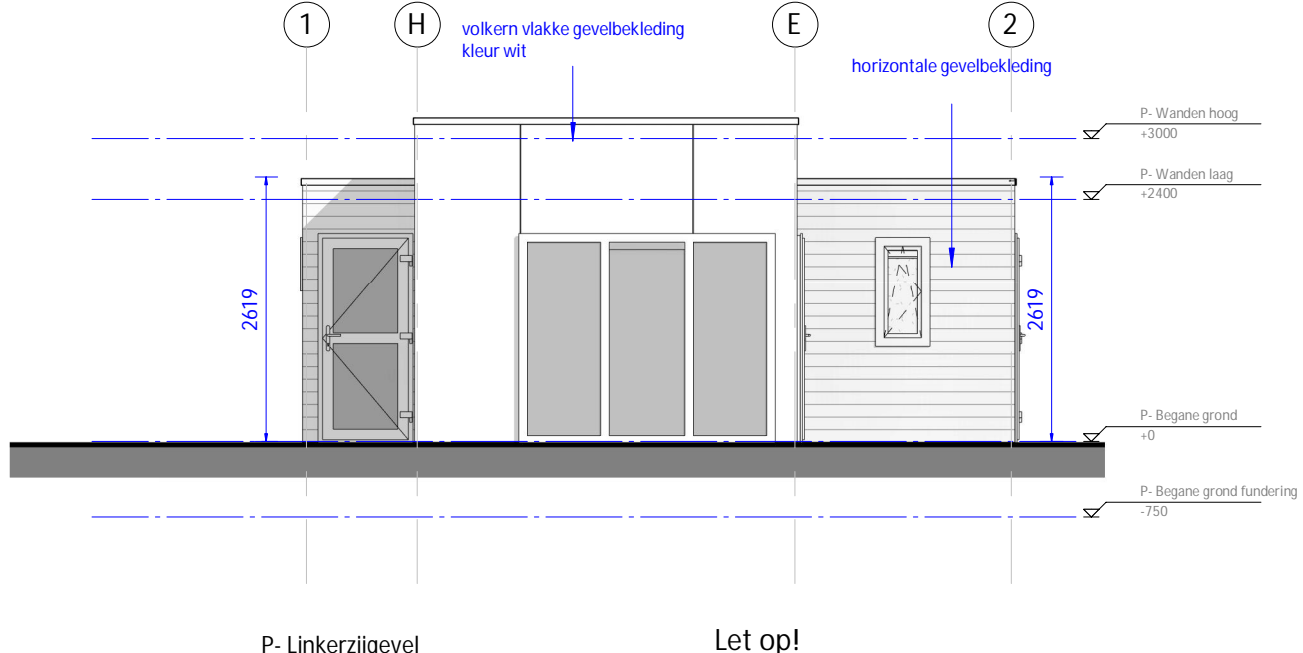

P- Linkerzijgevel
schaal: 1 : 40

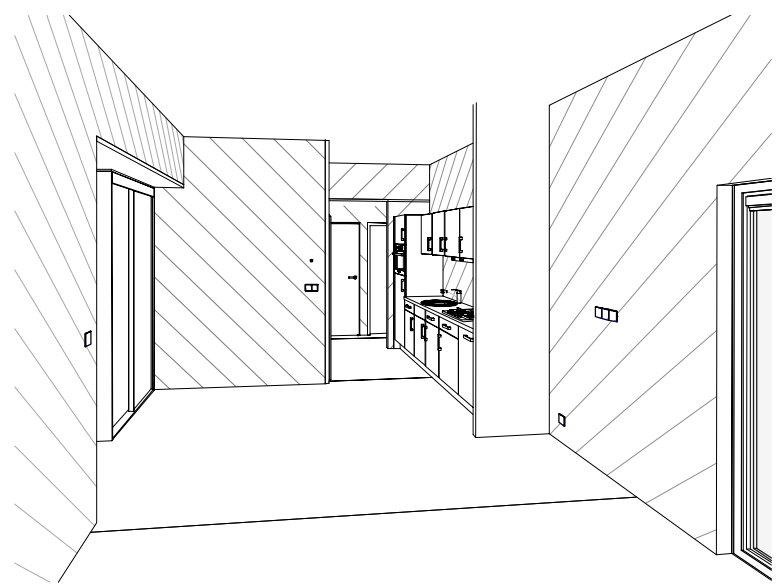

Let op!
Entredeuren met
verlaagde dorpel

Let op!
Aangepaste starthoogte
gevelbekleding



WANDERS MOBILE CHALETS | ETTENSEWEG 57 | 7071 AB | NEDERLAND | INFO@WANDERS-CHALETS.NL | WWW.WANDERS-CHALETS.NL

Omschrijving:			
Gevels			
Model:	Enkel 2 slpk.	Uitvoering:	links Oppervlakte: m ²
Project:			
Bestemming:			
Opdrachtgever:	SeaPromotion		
Vloermaat:	11.200 x 4.845mm	2:	4.500 x 2.145mm
Getekend:	EJA	Gewijzigd:	Gewijzigd:
Datum:	27-03-2018	A:	03-04-2018 EJA D:
Schaal:		B:	05-04-2018 EJA E:
Papierformaat:		C:	17-04-2018 EJA F:
Ordernummer:			

Cha8760

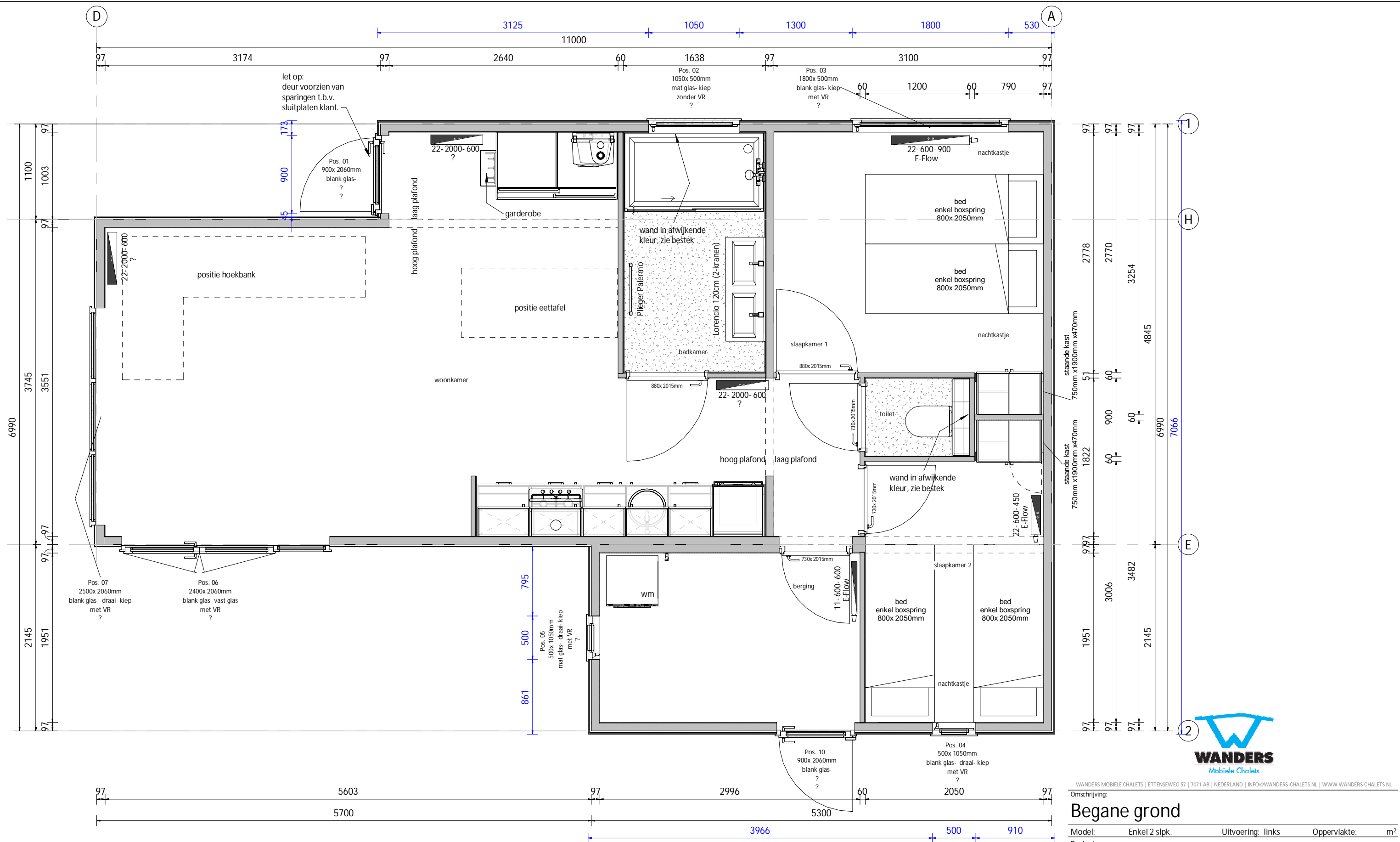

WANDERS MOBEIE CHALETS | ETTENSEWEG 57 | 7071 AB | NEDERLAND | INFO@WANDERS-CHALETS.NL | WWW.WANDERS-CHALETS.NL

Omschrijving:

Begane grond

Model: Enkel 2 slpk. Uitvoering: links Oppervlakte: m²

Project:

Bestemming:

Opdrachtgever: SeaPromotion

Vloermaat: 11.200 x 4.845mm 2: 4.500 x 2.145mm

Getekend: EJA Gewijzigd: Gewijzigd:

Datum: 27-03-2018 A: 03-04-2018 EJA D:

Schaal: - B: 05-04-2018 EJA E:









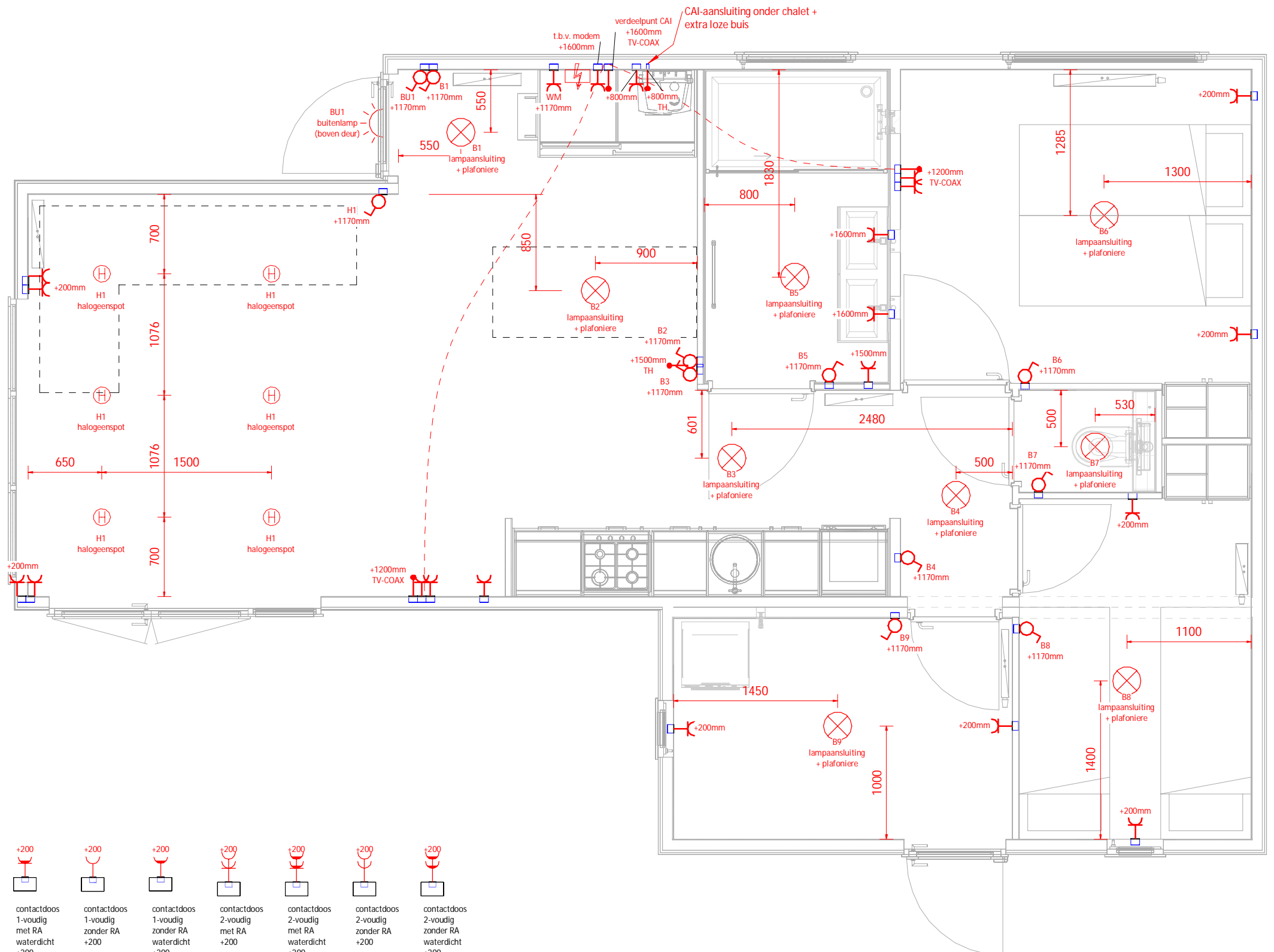

Papierformaat: - C: 17-04-2018 EJA F:









Ordernummer:







Cha8760

Deze tekening mag alleen met schriftelijke toestemming van Wanders Mobeie Chalets worden doorgegeven, gekopieerd, danwel op een andere manier worden vermenigvuldigd.



-  aansluitpunt bedraad TV-COAX +200
-  aansluitpunt bedraad TV-UTP +200
-  aansluitpunt onbedraad COAX-UTP +200
-  contactdoos 1-voudig met RA +200
-  contactdoos 1-voudig met RA waterdicht +200
-  contactdoos 1-voudig zonder RA +200
-  contactdoos 1-voudig zonder RA waterdicht +200
-  contactdoos 2-voudig met RA +200
-  contactdoos 2-voudig met RA waterdicht +200
-  contactdoos 2-voudig zonder RA +200
-  contactdoos 2-voudig zonder RA waterdicht +200

-  kruisschakelaar 1-polig +1170
-  schakelaar 1-polig +1170
-  schakelaar 1-polig +1170
-  dimmer 1-polig +1170
-  serieschakelaar 1-polig +1170
-  trekschakelaar 1-polig +1170
-  wisselschakelaar 1-polig +1170
-  wisselschakelaar 2-polig +1170
-  wisselschakelaar 2-polig +1170

-  groepenkast 1-fase/3-fase
-  badkamer/toilet ventilator
-  rookmelder
-  buitenlamp-aansluiting geschakeld
-  halogeenspot geschakeld
-  ledspot geschakeld
-  lampaansluiting geschakeld



WANDERS MOBILE CHALETS | ETTENSEWEG 57 | 7071 AB | NEDERLAND | INFO@WANDERS-CHALET.NL | WWW.WANDERS-CHALET.NL

Omschrijving: **Begane grond elektra**

Model:	Enkel 2 slpk.	Uitvoering:	links	Oppervlakte:	m ²
Project:					
Bestemming:					
Opdrachtgever:	SeaPromotion				
Vloermaat:	11.200 x 4.845mm	2:	4.500 x 2.145mm		
Getekend:	EJA	Gewijzigd:			
Datum:	27-03-2018	A:	03-04-2018	EJA	D:
Schaal:		B:	05-04-2018	EJA	E:
Papierformaat:		C:	17-04-2018	EJA	F:
Ordernummer:					

De maatvoering van de elektra-aansluiting in wanden en plafonds kunnen in werkelijkheid afwijken van de maatvoering die getoond wordt op de tekening. De afwijking kan ontstaan door constructieve samenhang van wanden, vloeren en plafonds.

Cha8760

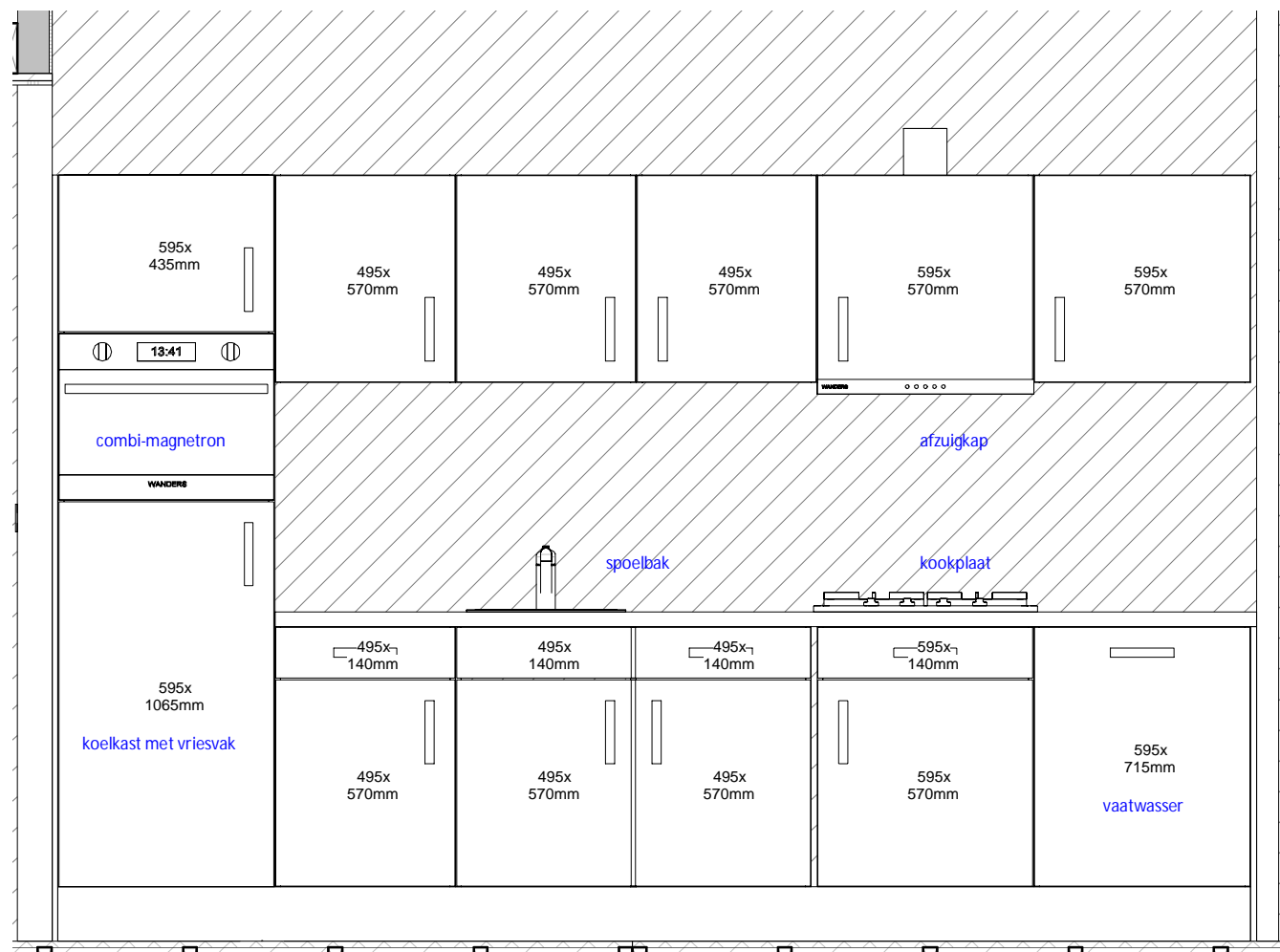

P- Keuken vooraanzicht
 schaal: 1 : 20

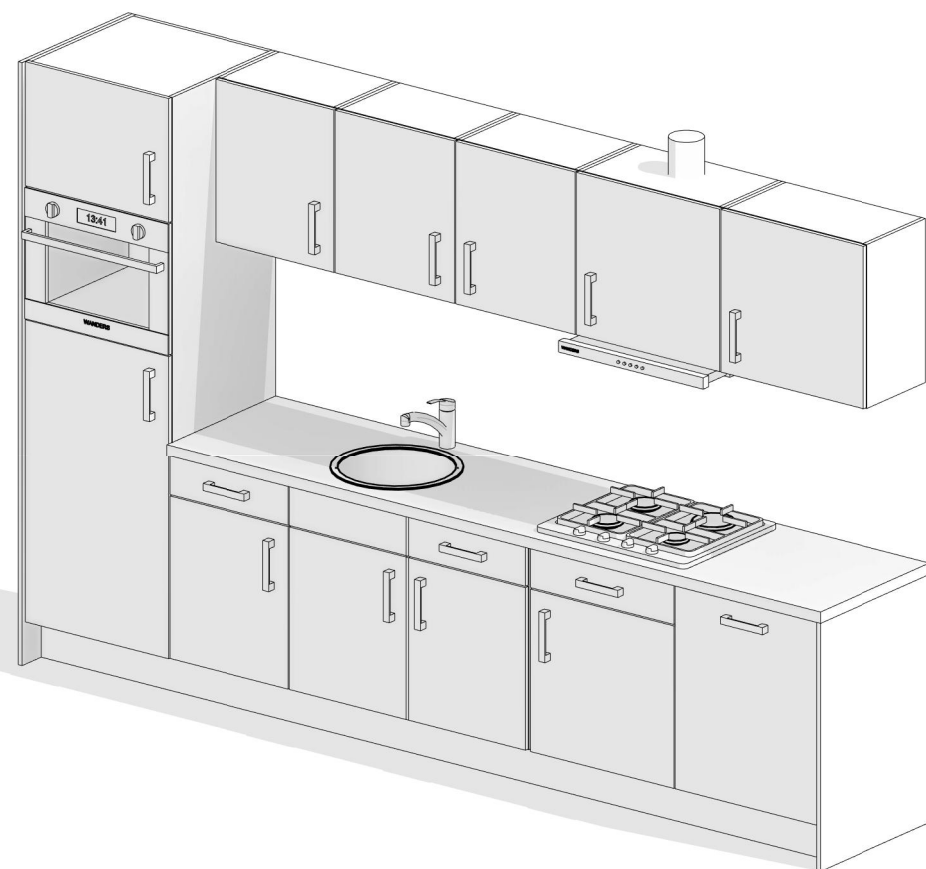

P- 3D keuken
 schaal:

Het uiterlijk van de getekende apparatuur kan afwijken van de werkelijk geplaatste apparatuur. De tekening geeft alleen een werkelijk beeld van de plaatsing.

009_keukenfrontjes		
Aantal	Hoogte	Breedte
3	140	495
6	570	495
1	140	595
1	435	595
3	570	595
1	715	595
1	1065	595
16		



WANDERS MOBIELE CHALETS | ETTENSEWEG 57 | 7071 AB | NEDERLAND | INFO@WANDERS-CHALETS.NL | WWW.WANDERS-CHALETS.NL

Omschrijving:

Keuken

Model: Enkel 2 slpk. Uitvoering: links Oppervlakte: m²

Project:

Bestemming:

Opdrachtgever: SeaPromotion

Vloermaat: 11.200 x 4.845mm 2: 4.500 x 2.145mm

Getekend: EJA Gewijzigd: Gewijzigd:

Datum: 27-03-2018 A: 17-04-2018 EJA D:

Schaal: B: E:

Papierformaat: C: F:

Ordernummer:

Cha8760